

SOLENOID VALVE



台灣專利號碼：新型M248943號

正常使用2000萬次以上壽命





能長時間作動不燒損，啟動壓力0.5kgf/cm²

規格

系列	VE1000	VE2000	VE3000	VE4000
使用流體	乾燥空氣			
操作壓力範圍	0.17~0.8MPa(1.7~8kgf/cm ²)			
耐壓力	1.0MPa(10kgf/cm ²)			
使用溫度	5°C~60°C (41°F~140°F)			
潤滑給油	潤滑或不潤滑			
反應靈敏度	0.05秒			
適用氣缸範圍	Ø12~Ø40mm	Ø40~Ø63mm	Ø63~Ø100mm	Ø80~Ø160mm
負載週期	100% ED			
配線端子	歐規標準配線插頭 DIN 43650			
電壓範圍	± 10%			
保護結構	IP65 防水/防塵			
絕緣等級	F級			
溫度範圍	30°C (86°F)			
消耗電力	DC24V:2.5W AC110V 50Hz:4.8VA AC110V 60Hz:4VA	DC24V:3W AC110V/220V 50Hz:6.0VA AC110V/220V 60Hz:4.9VA AC24V 60Hz:6 4VA	DC24V:5.5W AC110V 50Hz:8.4VA AC110V 60Hz:6.8VA AC120V 60Hz:8.8VA AC220V 50Hz:8.5VA AC220V 60Hz:6.9VA AC24V 60Hz:8.5VA	

系列	切換方式		接管口徑		有效斷面積	重量
			R,S	P,A,B	P→A/B	
VE1000	五口二位	單線圈	G1/8"	G1/8"	12mm ² (0.67CV)	120g
		雙線圈				175g
	五口三位	中位關閉			9mm ² (0.5CV)	195g
		中位開放				
中位壓力						
VE2000	五口二位	單線圈	G1/8"	G1/4"	18mm ² (1CV)	210g
		雙線圈				310g
	五口三位	中位關閉			12mm ² (0.7CV)	420g
		中位開放				
中位壓力						
VE3000	五口二位	單線圈	G1/4"	G3/8"	30mm ² (1.68CV)	300g
		雙線圈				385g
	五口三位	中位關閉			22mm ² (1.2CV)	525g
		中位開放				
中位壓力						
VE4000	五口二位	單線圈	G1/2"	G1/2"	50mm ² (2.8CV)	590g
		雙線圈				640g
	五口三位	中位關閉				770g
		中位開放				
中位壓力						

表示方法

VE	1	1	1	0	A11	L	M2
系列	型號	作動方式	配管口徑	配管方式	線圈電壓	插頭規格	連座數
	1 1000 2 2000 3 3000 4 4000	<p>1 單線圈</p>  <p>2 雙線圈</p>  <p>3 中位關閉</p>  <p>4 中位開放</p>  <p>5 中位壓力</p> 	<p>1 G1/8" (1000用)</p> <p>2 G1/4" (2000用)</p> <p>3 G3/8" (3000用)</p> <p>4 G1/2" (4000用)</p>	<p>0 沒有底座</p> <p>1 連座式</p>	<p>A11 AC110V 50/60Hz</p> <p>A22 AC220V 50/60Hz</p> <p>A24 AC24V</p> <p>D12 DC12V</p> <p>D24 DC24V</p>	<p>空 標準插頭 DIN 43650</p> <p>L 附燈插頭 DIN 43650</p> <p>S 保護迴路附燈插頭 DIN 43650</p>	<p>M2 2連</p> <p>...</p> <p>M10 10連</p>

外形尺寸圖

● VE1110 單線圈

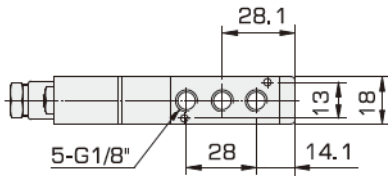
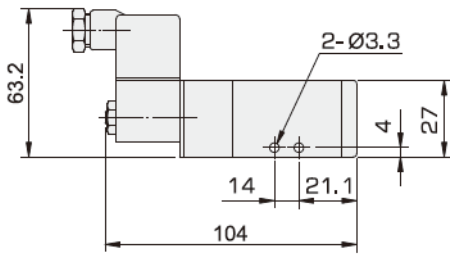
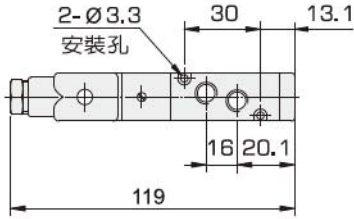

● VE1210 雙線圈

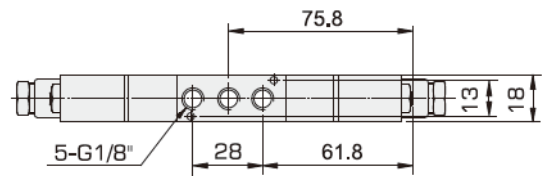
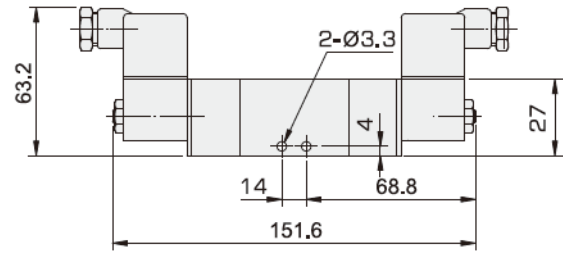
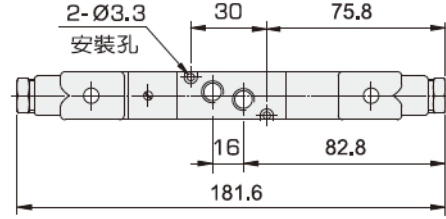

● VE1310 中位關閉

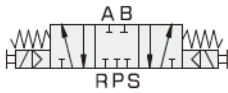

● VE1410 中位開放



● VE1510 中位壓力

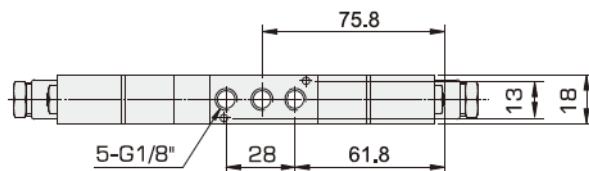
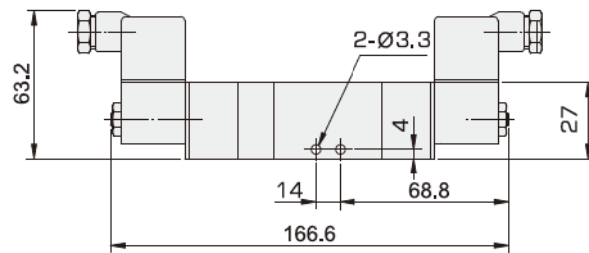
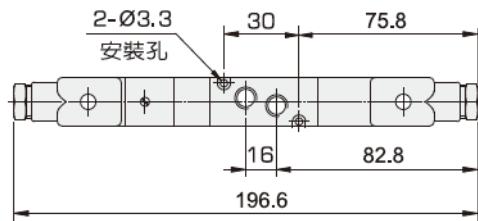

外形尺寸圖

● VE2120 單線圈

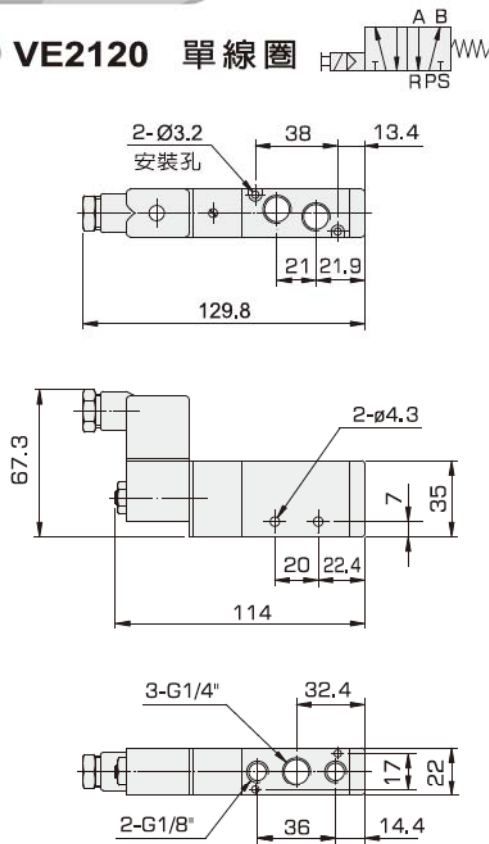

● VE2220 雙線圈

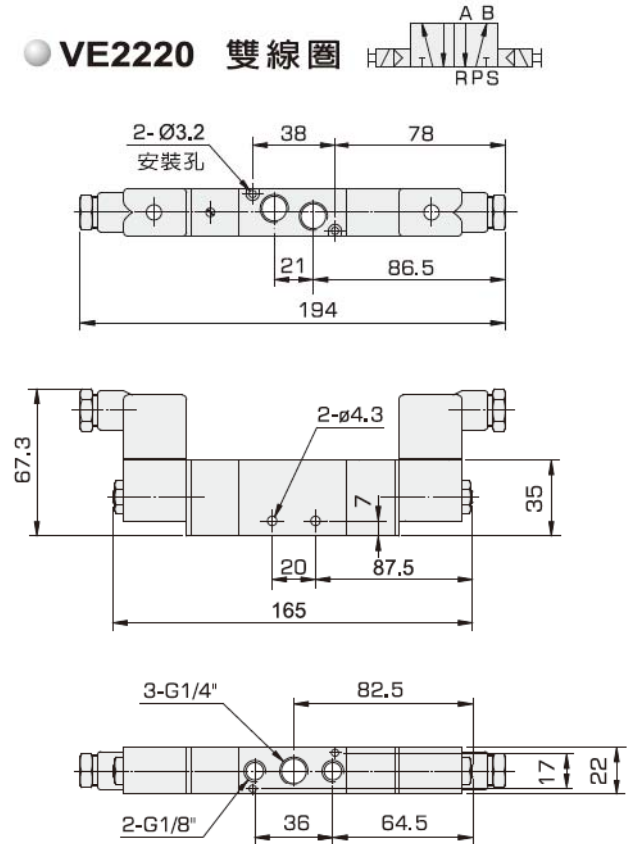

● VE2320 中位關閉

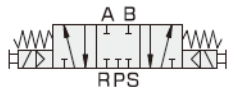

● VE2420 中位開放



● VE2520 中位壓力

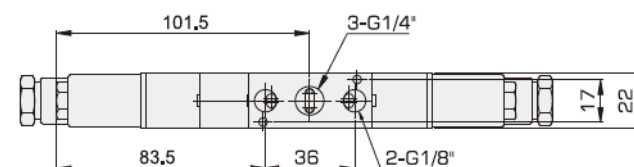
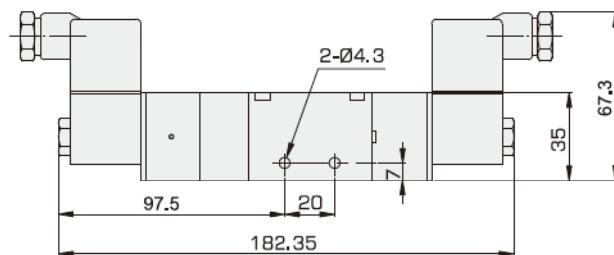
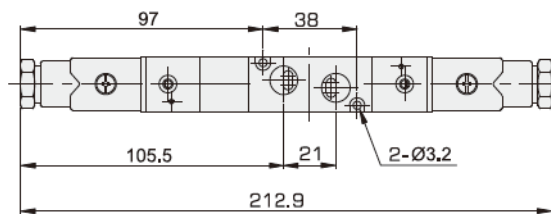

外形尺寸圖

● VE3130 單線圈

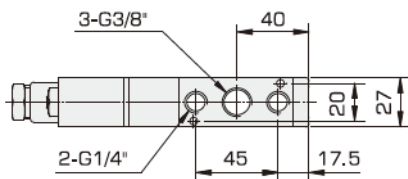
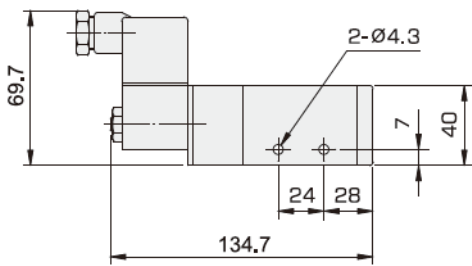
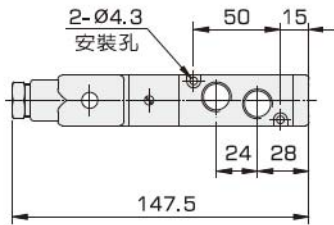

● VE3230 雙線圈

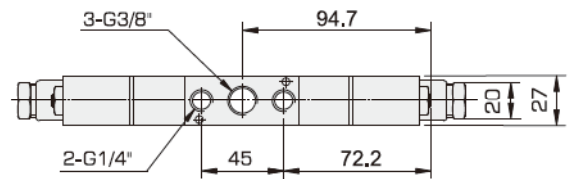
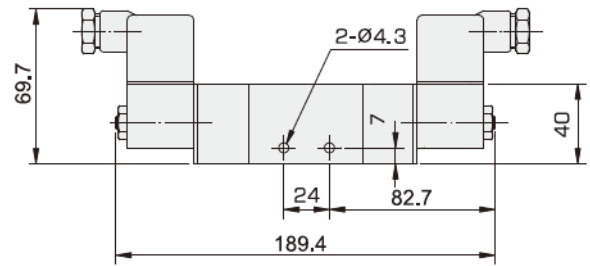
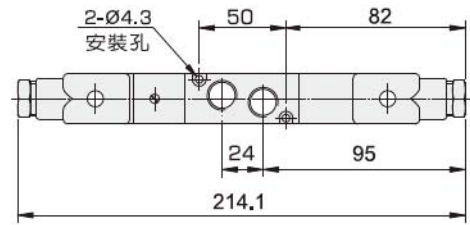

● VE3330 中位關閉

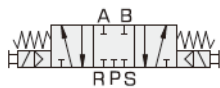

● VE3430 中位開放



● VE3530 中位壓力

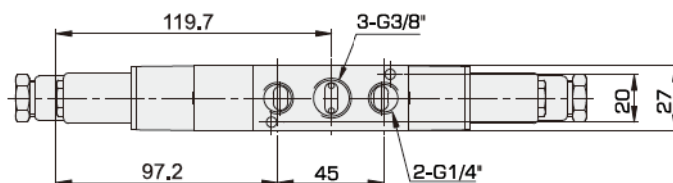
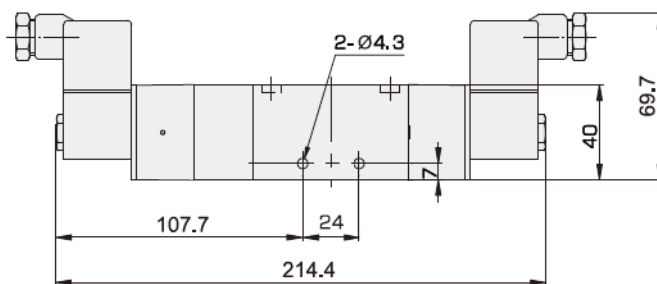
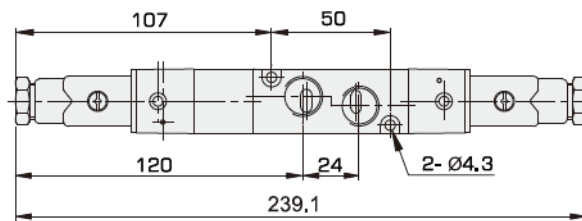

外形尺寸圖

● VE4140 單線圈

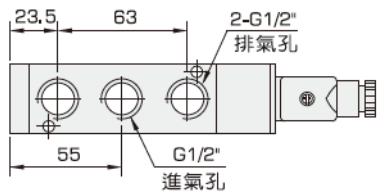
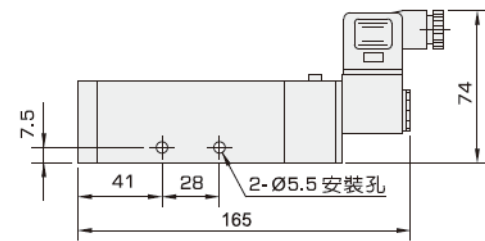
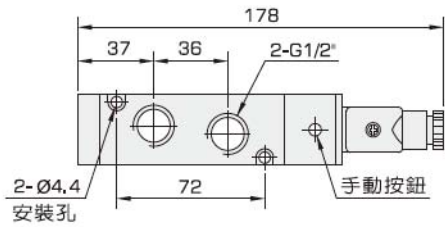
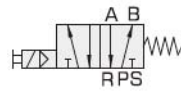

● VE4240 雙線圈

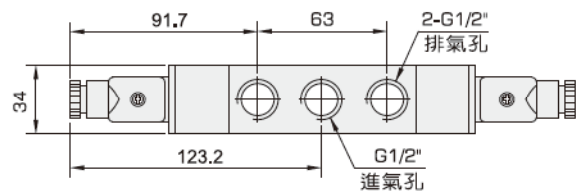
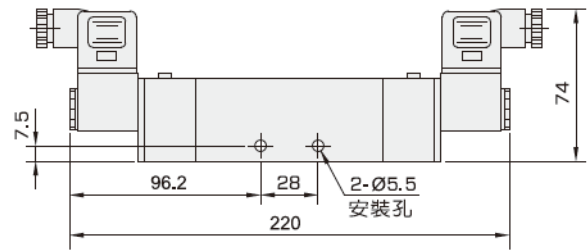
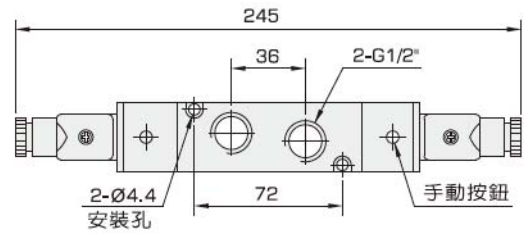

● VE4340 中位關閉

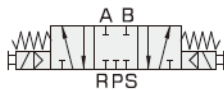

● VE4440 中位開放



● VE4540 中位壓力

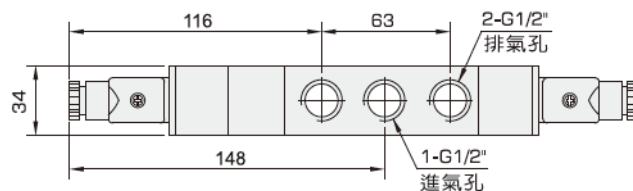
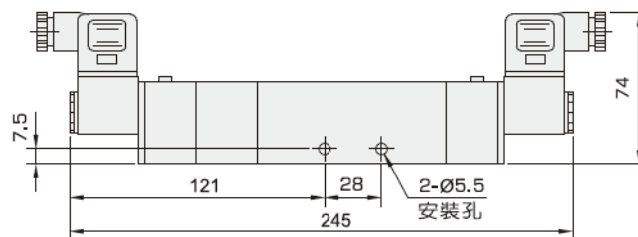
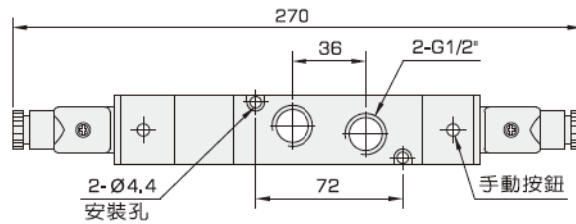

連座外形尺寸表

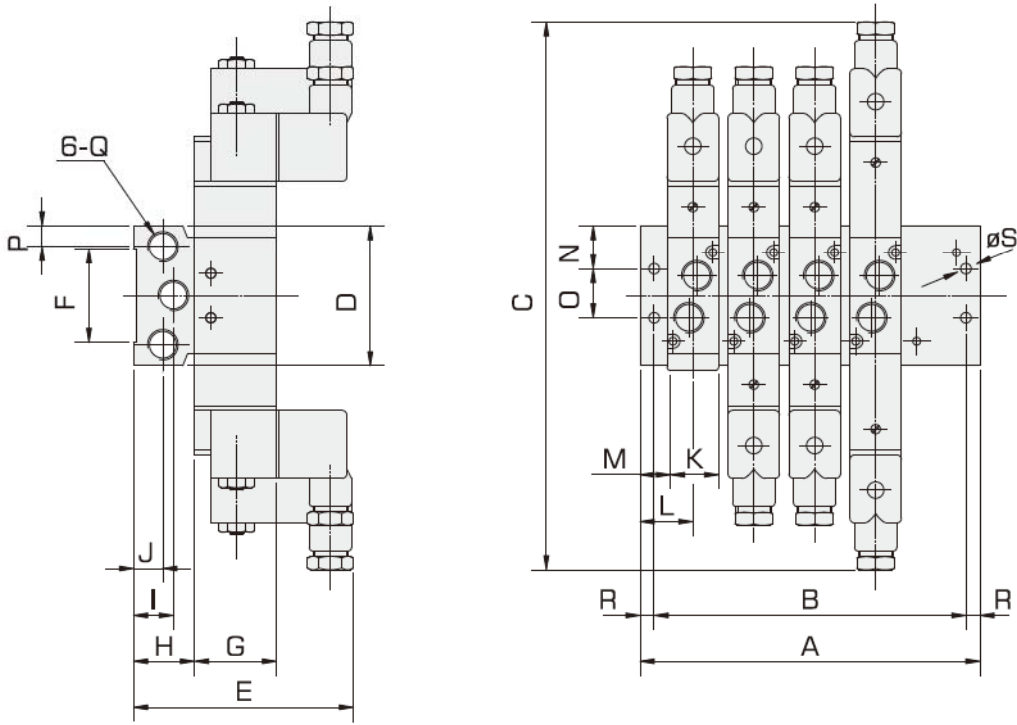

系列	連座	M2	M3	M4	M5	M6	M7	M8	M9	M10
VA1	A	57	76	95	114	133	152	171	190	209
	B	47	66	85	104	123	142	161	180	199
VA2	A	69	92	115	138	161	184	207	230	253
	B	57	80	103	126	149	172	195	218	241
VA3	A	87	116	145	174	203	232	261	290	319
	B	75	104	133	162	191	220	249	278	307
VA4	A	98	133	168	203	238	273	308	343	378
	B	84	119	154	189	224	259	294	329	364

系列	C	D	E	F	G	H	I	J	K	L	M	N	O	P	Q	R	ØS
VE1	196.6	58	88.2	36	27	23	14	10	18	19	10	19	20	8.75	G1/4"	5	4.5
VE2	212.9	60	94	42	35	26	16.5	11.5	22	23	12	19	22	9	G1/4"	6	5
VE3	239.1	80	97.2	50	40	27.5	14.5	14.5	27	29	15.5	25.8	28.4	11.5	G3/8"	6	5
VE4	270	100	113	68	50	39	20	20	34	31.25	14.25	34	32	18.5	G1/2"	7	5.5